



Orangery

Version: 3.0
July 08

For those who want light and space but with a differ



Ultraframe *Orangery*



The Orangery is a new take on the traditional atrium-style conservatory, brought up to date with the very latest technology from Ultraframe.

This stunning building floods the adjoining rooms with light, whilst the interior height of the Orangery creates a feeling of grandeur that is sure to appeal to the discerning homeowner.

Ultraframe offers a 'standardised' Orangery design with which comes off the shelf structural calculations - For full details please see the size matrix on p4.

Alternatively, for anything that falls outside of the matrix/ standard design details, we can offer a full bespoke design service along with structural calculations. Typically, it may take up to 7 days to quote, and a further 14 days for calculations to be provided by our structural engineers. (Please note a charge of £250 nett plus vat is payable when 'bespoke' structural calculations are requested).

Whichever option is chosen, rest assured that the Ultraframe team will help you throughout the process.

Help your customer stand out from the crowd and choose the Ultraframe Orangery.

...ence, then the new Orangery from Ultraframe is it.



Typical detail - Actual detail may vary

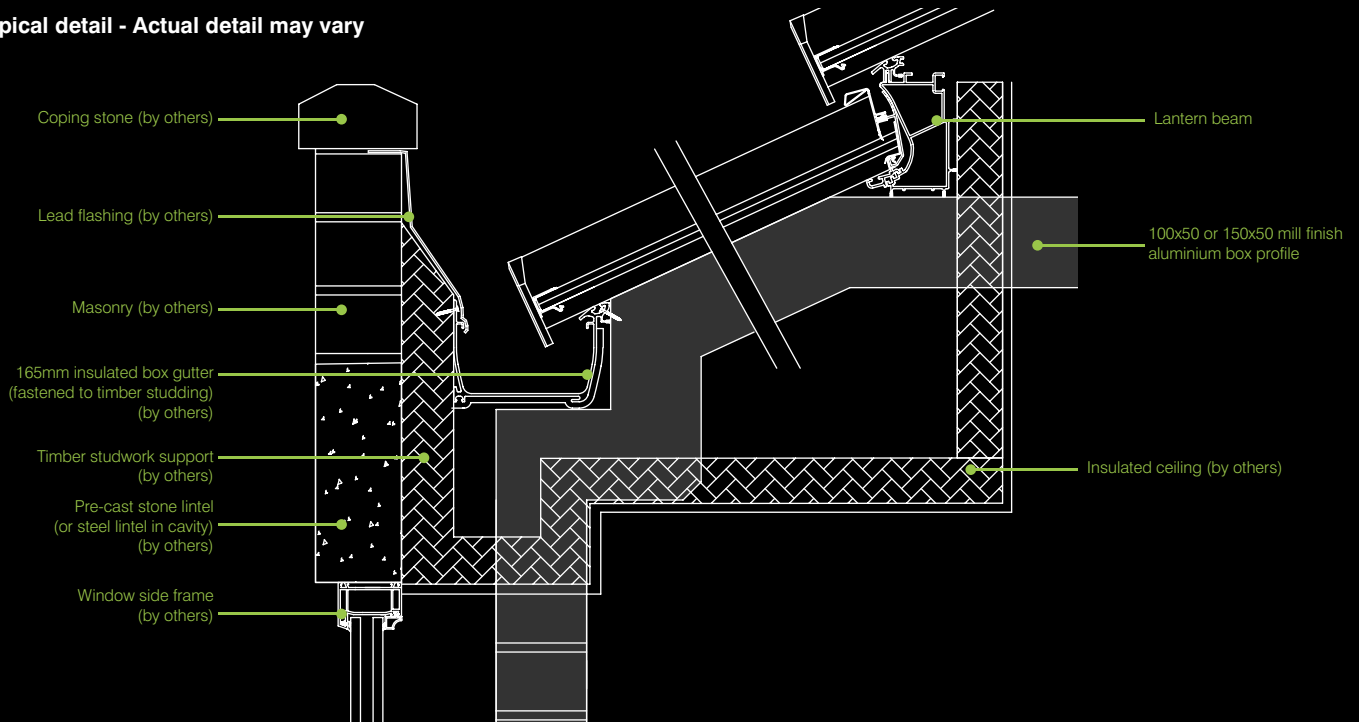

Technical Specification

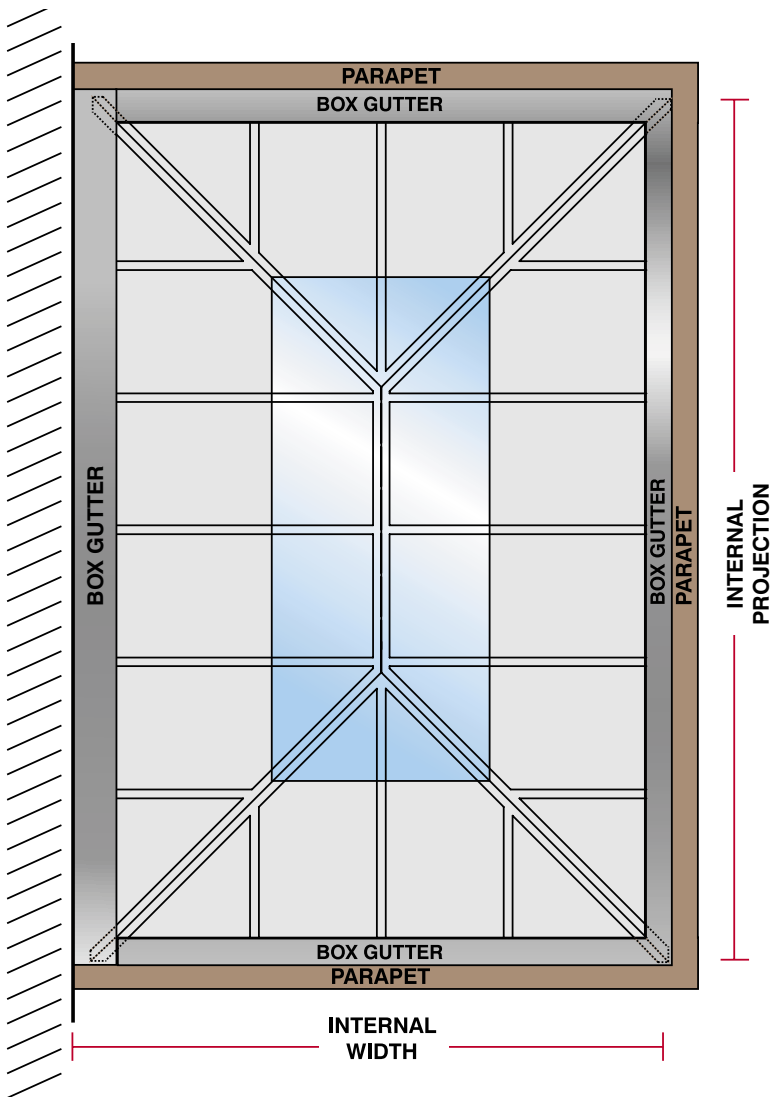

Specification:

- Roof includes 165mm insulated box gutter all round
- Hipped end included
- Each Orangery comes with 4 legs and 2 beams
- Roof is supplied unglazed - typically polycarbonate glazing is used in lower slope and Conservaglass in the upper slope but other combinations can be used too

Internal Width (mm)

	2500	2750	3000	3250	3500	3750	4000	4250	4500	4750	5000	5250	5500	5750	6000
2500															
2750															
3000	■														
3250	■	■													
3500	■	■	■												
3750	■	■	■	■											
4000	■	■	■	■	■										
4250	■	■	■	■	■	■									
4500	■	■	■	■	■	■	■								
4750	■	■	■	■	■	■	■	■							
5000	■	■	■	■	■	■	■	■	■						
5250	■	■	■	■	■	■	■	■	■	■					
5500	■	■	■	■	■	■	■	■	■	■	■				
5750	■	■	■	■	■	■	■	■	■	■	■	■			
6000	■	■	■	■	■	■	■	■	■	■	■	■	■		

■ Standard Orangeries

Orangeries can be supplied in the 'Green Zone'

The matrix (left) showing various Orangeries can be used confidently to prepare your project details. Please complete the enquiry form attached to enable us to respond to your requirements.

Standard Orangeries from the matrix must comply with the following before they can be issued with 'off the shelf' structural calculations:-

- Pitch 25° (same pitch all round)
- Wind uplift limited to 1.0KN/m²
- 165mm box gutter all round
- Minimum ridge length required of 500mm

If a different pitch is required, wind uplift is over 1.0KN/m² or you require a size/ configuration different to the matrix please call 0870 414 1002.

Example Orangery

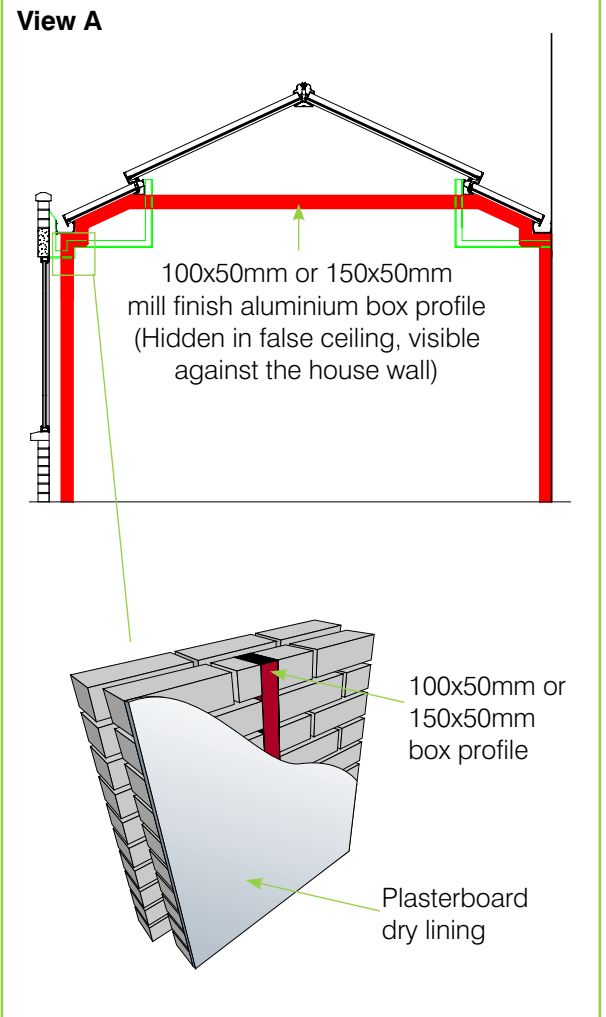
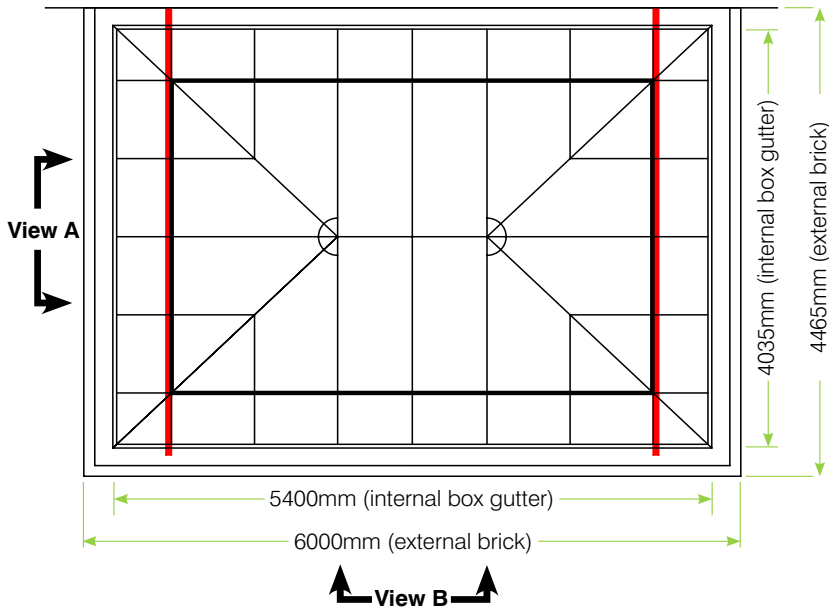

Cross Section

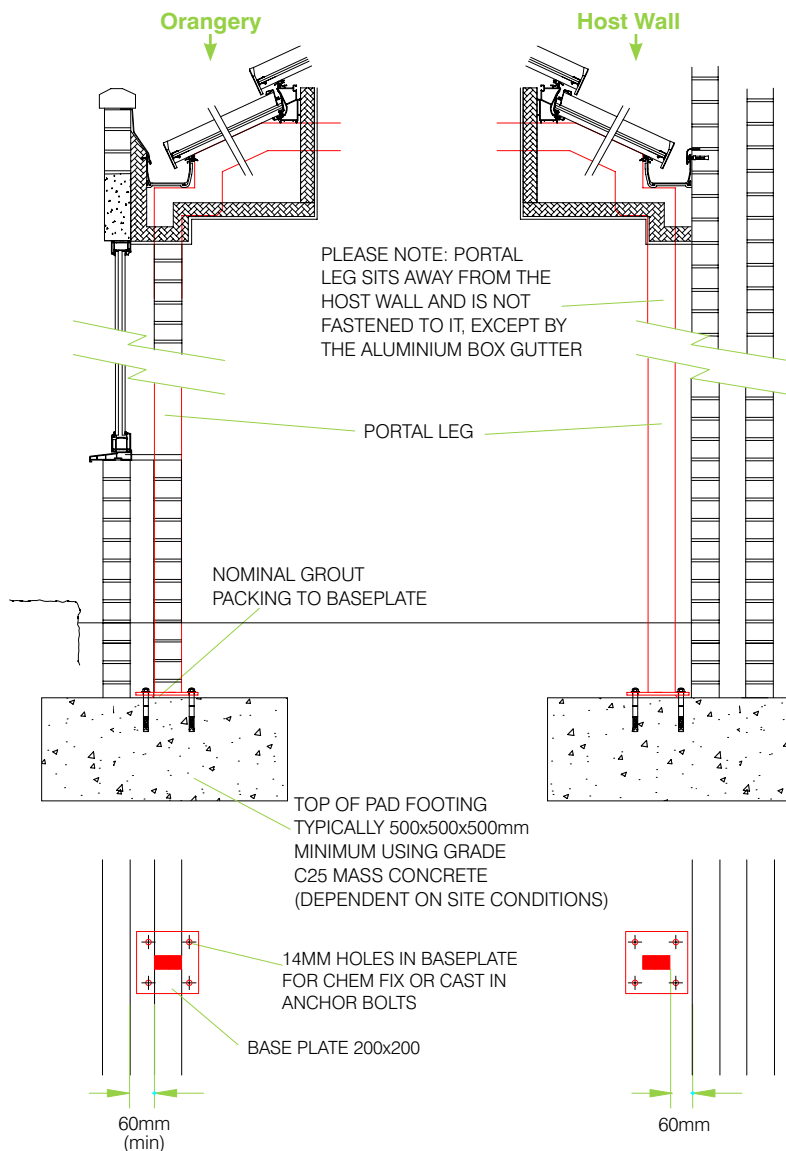

View B

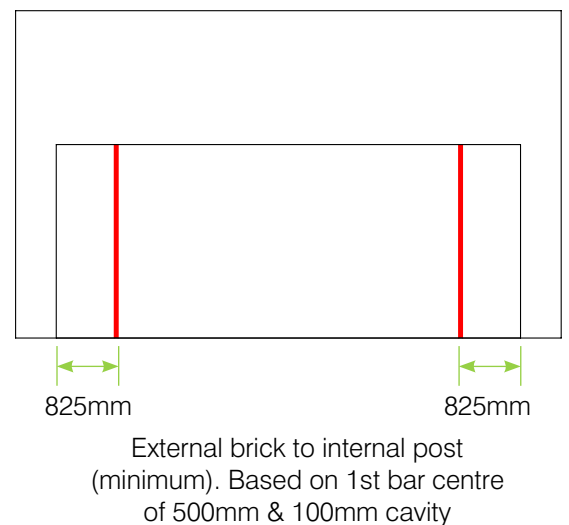

ultraframe *Orangery*

Roof order/enquiry form

- PARAPET WALLS ARE REQUIRED ON ALL THREE ELEVATIONS.
- 165MM BOX GUTTER IS USED ON ALL SIDES

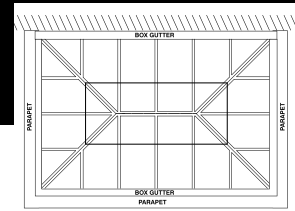

ORANGERY PLAN

Please supply dimensions for the following elevations and include the preferred location of windows and doors.

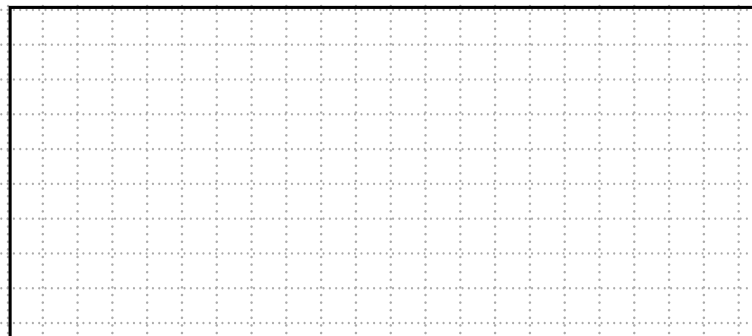

EXISTING BUILDING - DIMENSION DOORS AND WINDOWS

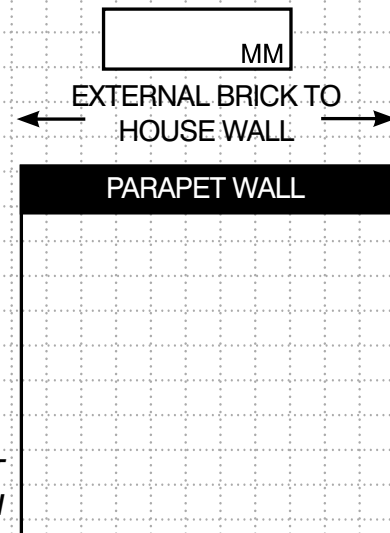
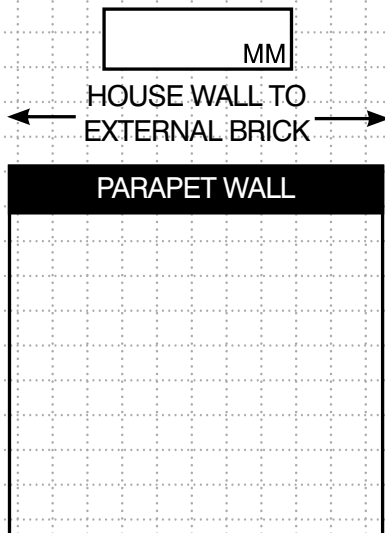
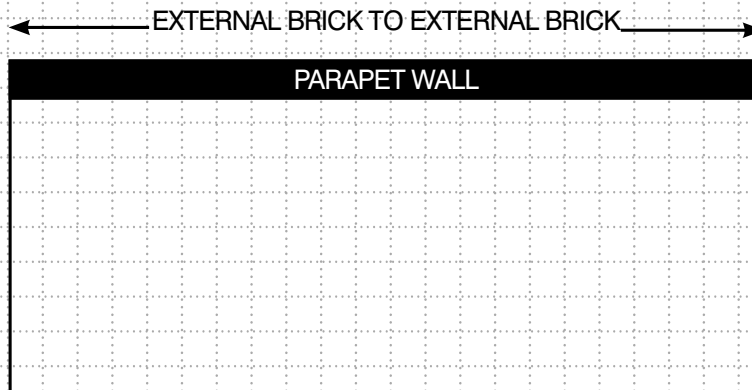

NOTE: The desired layout (including the quantity & position of windows and doors) may be subject to change due to structural requirements for the roof.

Ultraframe is a trading name of Ultraframe (UK) Ltd
Conservaglass, is a registered trademark of Ultraframe (UK) Ltd.

ultraframe

Ultraframe (UK) Ltd, Salthill Road, Clitheroe, Lancashire. BB7 1PE

www.ultraframe.co.uk